

STAGE3 6427

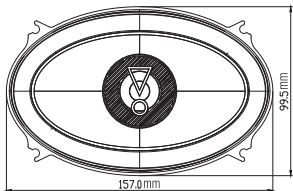

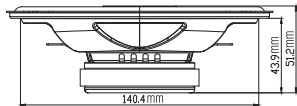

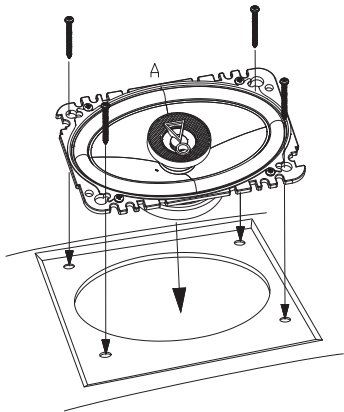
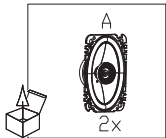
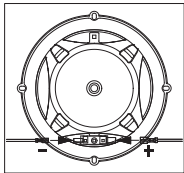
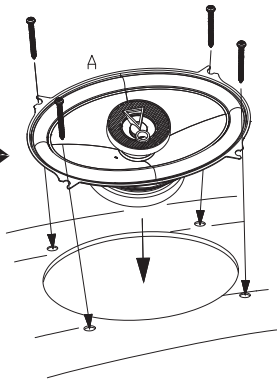
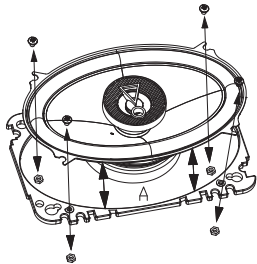

Specifiche

- Descrizione: Diffusore per auto coassiale a 2 vie da 100x152 mm
- Tenuta in potenza: 35 W RMS, 175 W di picco
- Sensibilità (2,83 V/1 m): 91 dB
- Risposta in frequenza: 75 Hz - 20 kHz
- Impedenza: 3 ohm

Parametri di Thiele-Smalll

- BL (Tm): 3.146
- DCR (ohms): 2.36
- Mms (g): 8.151
- Sd (cm²): 86.59
- Cms (μm/N): 0.272
- Vas (l): 2.884
- Fs (Hz): 106.9
- Qes: 1.307
- Qms: 13.178
- Qts: 1.189
- Crossover Point: 6kHz