

STAGE3 527

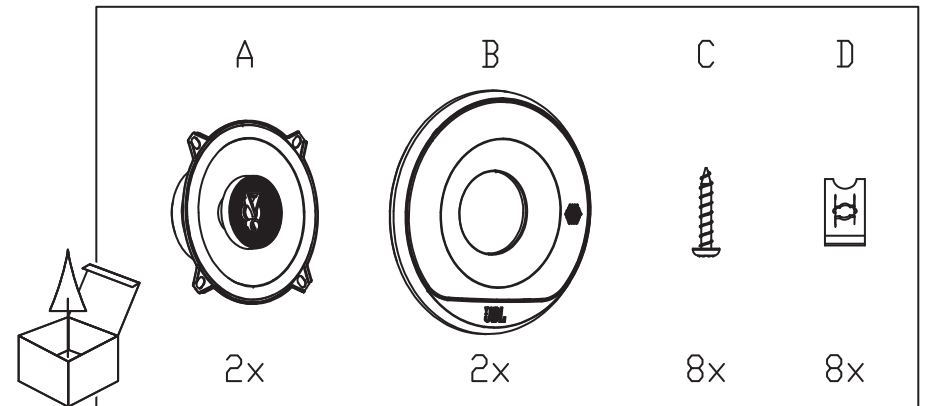

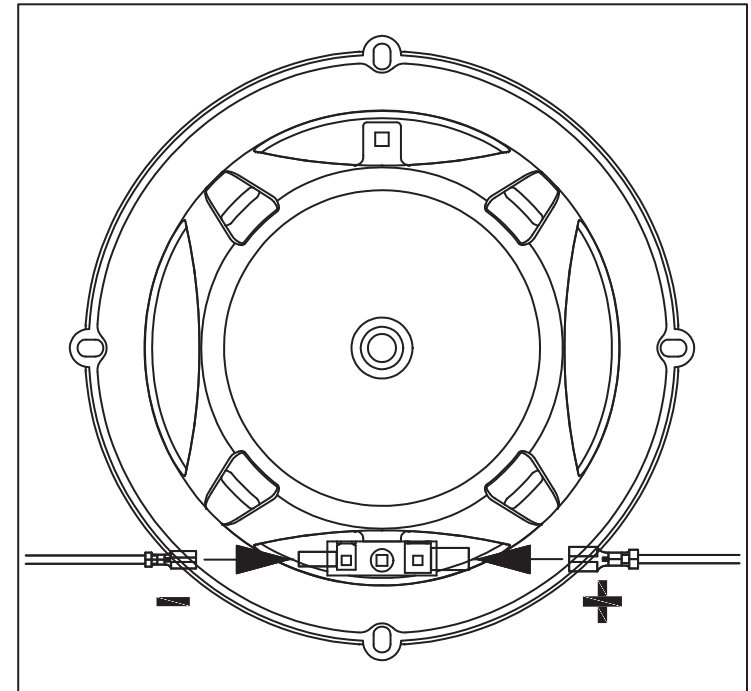
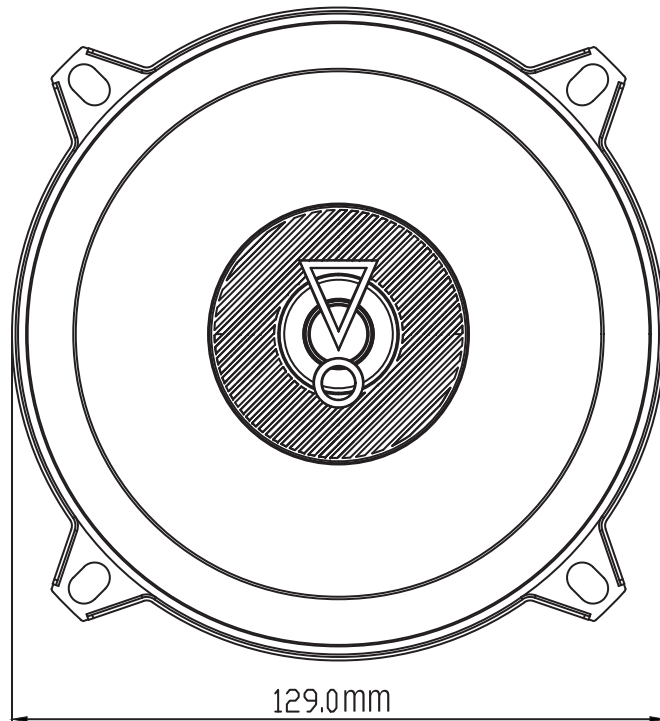
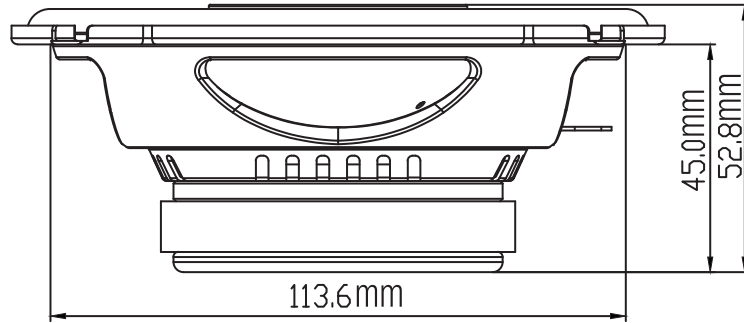
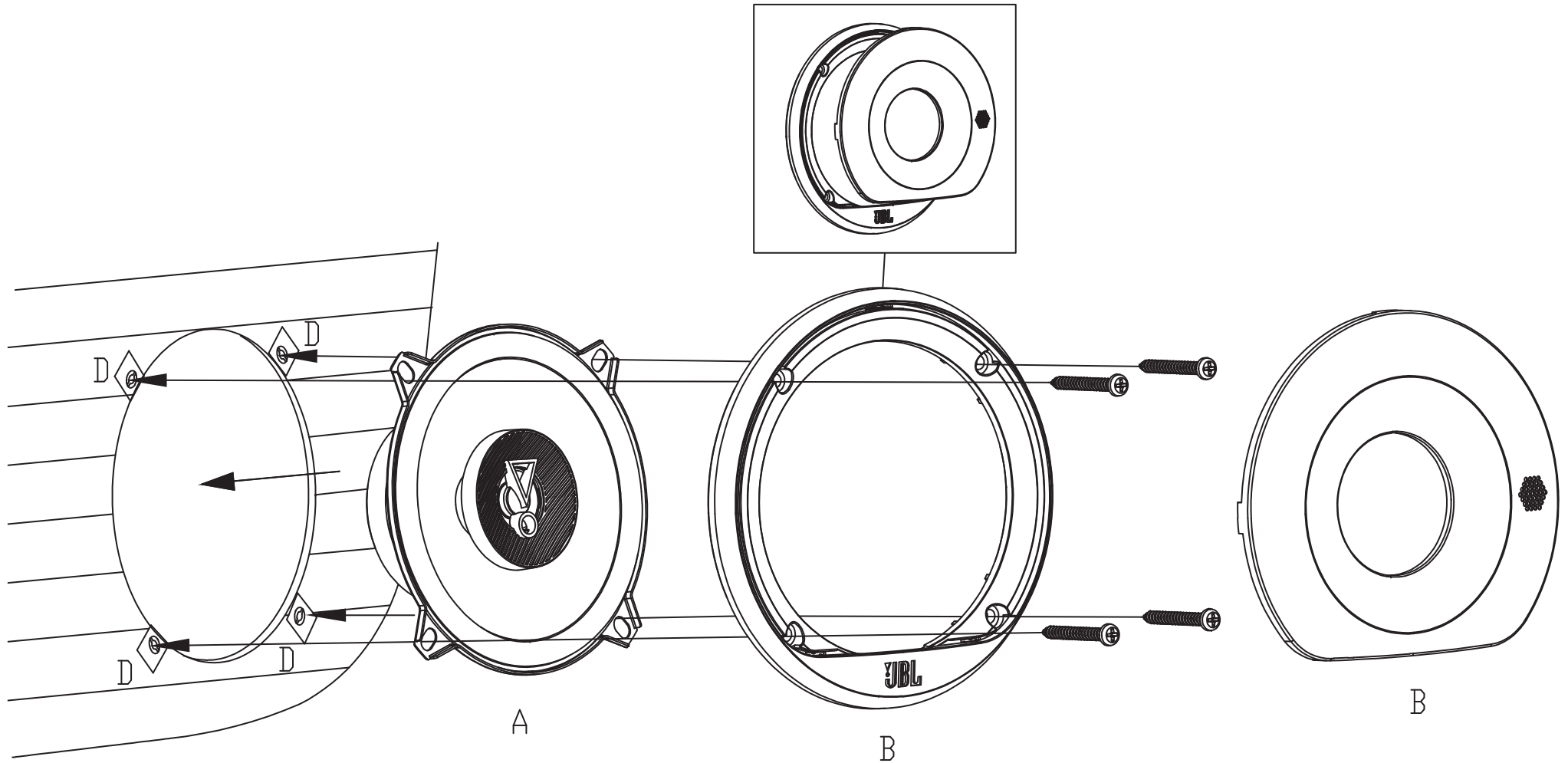

Specifiche

- Descrizione: Diffusore per auto coassiale a 2 vie da 130 mm
- Tenuta in potenza: 40 W RMS, 200 W di picco
- Sensibilità (2,83 V/1 m): 91 dB
- Risposta in frequenza: 75 Hz - 20 kHz
- Impedenza: 3 ohm

Parametri di Thiele-Small

- BL (Tm): 3.148
- DCR (ohms): 2.61
- Mms (g): 9.81
- Sd (cm²): 102.07
- Cms (µm/N): 0.281
- Vas (l): 4.1374
- Fs (Hz): 95.9
- Qes: 1.555
- Qms: 13.546
- Qts: 1.395
- Crossover Point: 6kHz